

# Dell PowerVault NX3300 Systems Getting Started Guide

Regulatory Model: E16S Series  
Regulatory Type: E16S001



# Notes, Cautions, and Warnings



**NOTE:** A NOTE indicates important information that helps you make better use of your computer.



**CAUTION:** A CAUTION indicates either potential damage to hardware or loss of data and tells you how to avoid the problem.



**WARNING:** A WARNING indicates a potential for property damage, personal injury, or death.

**Information in this publication is subject to change without notice.**

**© 2012 Dell Inc. All rights reserved.**

Reproduction of these materials in any manner whatsoever without the written permission of Dell Inc. is strictly forbidden.

Trademarks used in this text: Dell™, the Dell logo, Dell Precision™, OptiPlex™, Latitude™, PowerEdge™, PowerVault™, PowerConnect™, OpenManage™, EqualLogic™, Compellent™, KACE™, FlexAddress™, Force10™ and Vostro™ are trademarks of Dell Inc. Intel®, Pentium®, Xeon®, Core® and Celeron® are registered trademarks of Intel Corporation in the U.S. and other countries. AMD® is a registered trademark and AMD Opteron™, AMD Phenom™ and AMD Sempron™ are trademarks of Advanced Micro Devices, Inc. Microsoft®, Windows®, Windows Server®, Internet Explorer®, MS-DOS®, Windows Vista® and Active Directory® are either trademarks or registered trademarks of Microsoft Corporation in the United States and/or other countries. Red Hat® and Red Hat® Enterprise Linux® are registered trademarks of Red Hat, Inc. in the United States and/or other countries. Novell® and SUSE® are registered trademarks of Novell Inc. in the United States and other countries. Oracle® is a registered trademark of Oracle Corporation and/or its affiliates. Citrix®, Xen®, XenServer® and XenMotion® are either registered trademarks or trademarks of Citrix Systems, Inc. in the United States and/or other countries. VMware®, Virtual SMP®, vMotion®, vCenter® and vSphere® are registered trademarks or trademarks of VMware, Inc. in the United States or other countries. IBM® is a registered trademark of International Business Machines Corporation.

Other trademarks and trade names may be used in this publication to refer to either the entities claiming the marks and names or their products. Dell Inc. disclaims any proprietary interest in trademarks and trade names other than its own.

2012 — 06

Rev. A00

# Installation And Configuration

 **WARNING:** Before performing the following procedure, review the safety instructions that came with the system.

## Unpacking A Rack System

Unpack your system and identify each item.

Assemble the rails and install the system in the rack following the safety instructions and the rack installation instructions provided with your system.

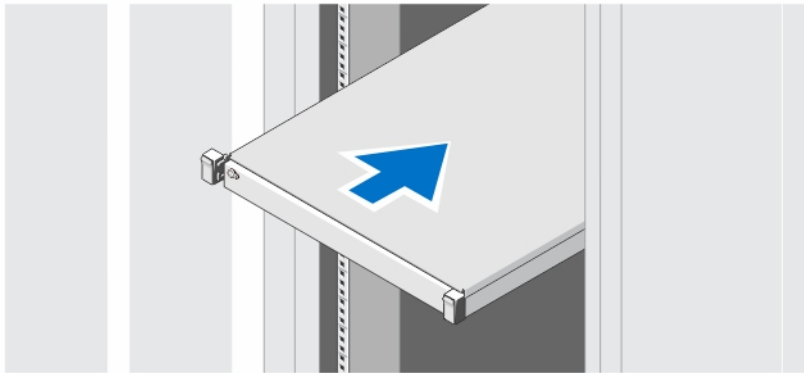

**Figure 1. Installing the Rails and System in a Rack**

## Optional—Connecting the Keyboard, Mouse, and Monitor

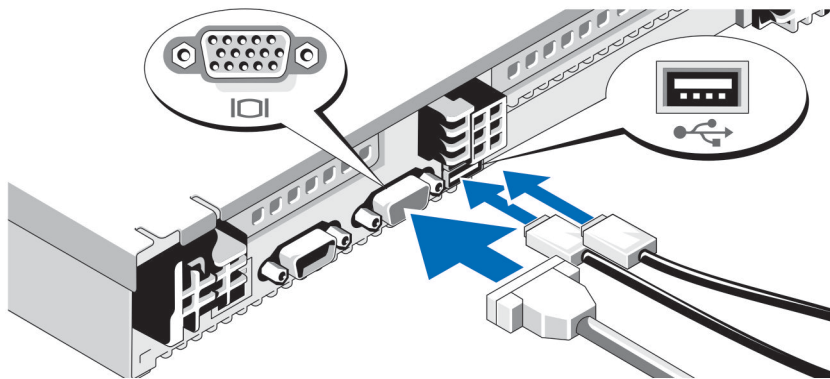
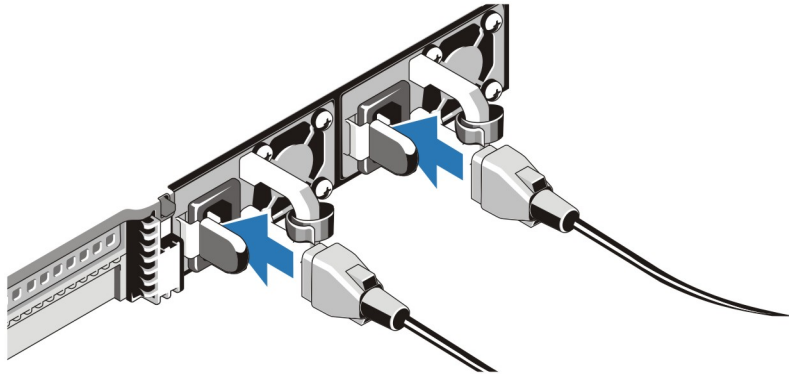

**Figure 2. Connecting Keyboard, Mouse, and Monitor**

Connect the keyboard, mouse, and monitor (optional).

The connectors on the back of your system have icons indicating which cable to plug into each connector. Be sure to tighten the screws (if any) on the monitor's cable connector.

## Connecting The Power Cable(s)



**Figure 3. Connecting Power Cable(s)**

Connect the system's power cable(s) to the system and, if a monitor is used, connect the monitor's power cable to the monitor.

## Securing The Power Cable(s)

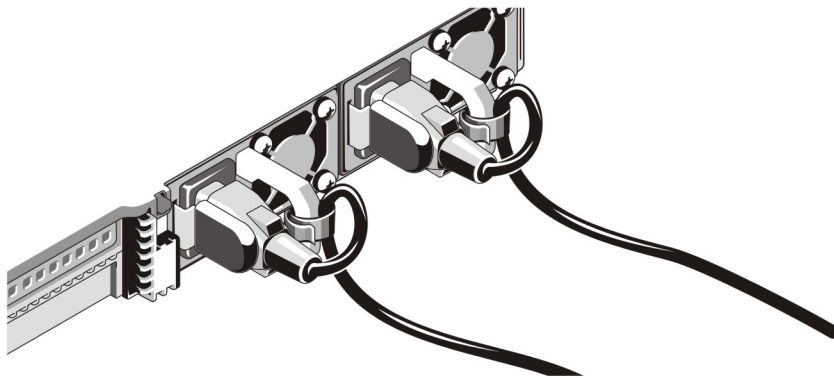
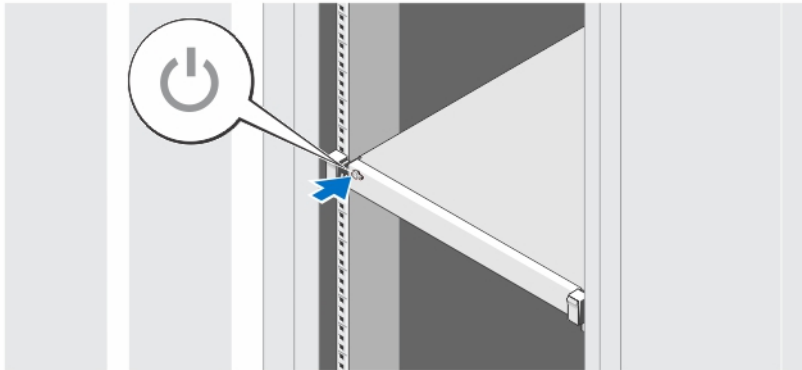

**Figure 4. Securing Power Cable(s)**

Bend the system power cable(s), as shown in the illustration, and attach to the cable strap.

Plug the other end of the power cable(s) into a grounded electrical outlet or a separate power source such as an uninterruptible power supply (UPS) or a power distribution unit (PDU).

## Turning On The System



**Figure 5. Turning on the System**

Press the power button on the system. The power indicator should light.

## Installing The Optional Bezel

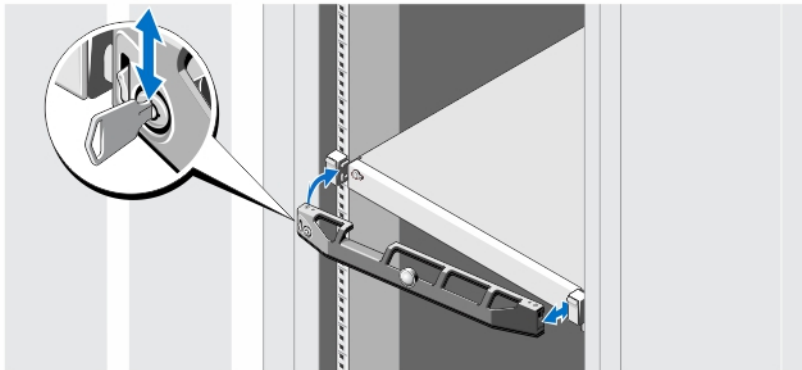

**Figure 6. Installing the Optional Bezel**

Install the bezel (optional).

## Dell Software License Agreement

Before using your system, read the Dell Software License Agreement that came with your system. You must consider any media of Dell-installed software as BACKUP copies of the software installed on your system's hard drive. If you do not accept the terms of the agreement, call the customer assistance telephone number. For customers in the United States, call 800-WWW-DELL (800-999-3355). For customers outside the United States, visit [support.dell.com](http://support.dell.com) and select your country or region from the top of the page.

## Other Information You May Need

 **WARNING:** See the safety and regulatory information that shipped with your system. Warranty information may be included within this document or as a separate document.

- The *Owner's Manual* provides information about system features and describes how to troubleshoot the system and install or replace system components. This document is available online at [support.dell.com/manuals](http://support.dell.com/manuals).
- The rack documentation included with your rack solution describes how to install your system into a rack, if required.
- Any media that ships with your system that provides documentation and tools for configuring and managing your system, including those pertaining to the operating system, system management software, system updates, and system components that you purchased with your system.

 **NOTE:** Always check for updates on [support.dell.com/manuals](http://support.dell.com/manuals) and read the updates first because they often supersede information in other documents.

## Obtaining Technical Assistance

If you do not understand a procedure in this guide or if the system does not perform as expected, see your *Owner's Manual*. Dell offers comprehensive hardware training and certification. See [dell.com/training](http://dell.com/training) for more information. This service may not be offered in all locations.

## NOM Information

The following information is provided on the device described in this document in compliance with the requirements of the official Mexican standards (NOM):

Importer:	Dell Inc. de México, S.A. de C.V. Paseo de la Reforma 2620 -11° Piso Col. Lomas Altas 11950 México, D.F.
Model number:	E16S
Supply voltage:	100–240 V CA (with 495 W, 750 W, and 1100 W AC Power Supply Unit) or -(48–60) V de CC (with 1100 W DC power supply unit)
Frequency:	50/60 Hz (AC power supply unit)
Current consumption:	12–6.5 A (X 2) (per 1100 W AC power supply unit) 10–5 A (X 2) (per 750 W AC power supply unit) 6.5–3 A (X 2) (per 495 W AC power supply unit) 32 A (X 2) (per 1100 W DC power supply unit)

 **NOTE:** (X #), # = Maximum number of power supplies per system.

## Technical Specifications



 **NOTE:** The following specifications are only those required by law to ship with your system. For a complete and current listing of the specifications for your system, go to [support.dell.com](http://support.dell.com).

---

**Power**

---

**AC Power Supply (per power supply)**

Wattage	495 W, 750 W, or 1100 W
Heat dissipation	1908 BTU/hr maximum (495 W power supply) 2891 BTU/hr maximum (750 W power supply) 4100 BTU/hr maximum (1100 W power supply)
 <b>NOTE:</b> Heat dissipation is calculated using the power supply wattage rating.	
Voltage	100–240 V AC, autoranging, 50/60 Hz
 <b>NOTE:</b> This system is also designed to be connected to IT power systems with a phase to phase voltage not exceeding 230 V.	

**DC Power Supply (per power supply) (when available)**

Wattage	1100 W
Heat dissipation	4416 BTU/hour maximum
 <b>NOTE:</b> Heat dissipation is calculated using the power supply wattage rating.	
Voltage	-(48–60) V DC

**Battery**

Coin-cell battery	3 V CR2032 Lithium coin cell
-------------------	------------------------------

---

**Physical**

---

Height	42.8 mm (1.68 inch)
Width	482.4 mm (18.99 inch) with rack latches. 434 mm (17.08 inch) without rack latches.
Depth	700.5 mm (27.58 inch)
Weight	
Maximum Configuration	15.52 kg (34.14 lb)
Empty	8.58 kg (18.92 lb)

---

**Environmental**

---

 **NOTE:** For additional information about environmental measurements for specific system configurations, see [dell.com/environmental\\_datasheets](http://dell.com/environmental_datasheets).

**Temperature**

Operating	Continuous operation: 10 °C to 35 °C (50 °F to 95 °F) at 10% to 80% relative humidity (RH), with 26 °C max dew point. De-rate maximum allowable dry bulb temperature at 1 °C/300 m above 900 m (1 °F per 550 ft).
-----------	---

---

## Environmental

---

 **NOTE:** For information on supported expanded operating temperature range and configurations, see [support.dell.com/manuals](http://support.dell.com/manuals).

Storage -40–65 °C (-40–149 °F) with a maximum temperature gradation of 20 °C per hour

### Relative humidity

Operating 10% to 80% (noncondensing) at a maximum wet bulb temperature of 26 °C (79 °F)

Storage 5% to 95% (noncondensing) at a maximum wet bulb temperature of 33 °C (91 °F)

### Maximum vibration

Operating 0.26 Grms at 5–350 Hz (all operation orientations)

Storage 1.87 Grms at 10–500 Hz for 15 min (all six sides tested)

### Maximum shock

Operating One shock pulse in the positive z axis (one pulse on each side of the system) of 31 G for 2.6 ms in the operational orientation

Storage Six consecutively executed shock pulses in the positive and negative x, y, and z axes (one pulse on each side of the system) of 71 G for up to 2 ms

Six consecutively executed shock pulses in the positive and negative x, y, and z axes (one pulse on each side of the system) of 32 G faired square wave pulse with velocity change at 270 inches/second (685 centimeters/second)

### Altitude

Operating -15.2–3048 m (-50–10,000 ft)

 **NOTE:** For altitudes above 2950 ft, the maximum operating temperature is derated 1 °F/550 ft.

Storage -15.2–10,668 m (-50–35,000 ft)

 **NOTE:** The system can be air shipped.

### Particulate Contamination

Air Filtration Data center air filtration as defined by ISO Class 8 per ISO 14644-1 with a 95% upper confidence limit.

 **NOTE:** Air entering the data center must have MERV11 or MERV13 filtration.



---

## Environmental

---

 **NOTE:** Applies to data center environments only. Air filtration requirements do not apply to IT equipment designed to be used outside a data center, in environments such as an office or factory floor.

Conductive Dust

Air must be free of conductive dust, zinc whiskers, or other conductive particles.

 **NOTE:** Applies to data center and non-data center environments.

Corrosive Dust

 **NOTE:** Applies to data center and non-data center environments.

- Air must be free of corrosive dust.
- Residual dust present in the air must have a deliquescent point less than 60% relative humidity.

### Airborne Contaminant Level

Class

G1 as defined by ISA-S71.04-1985.

### Gaseous Contamination

Copper Coupon Corrosion Rate

<300 Å/month per Class G1 as defined by ANSI/ISA71.04-1985.

Silver Coupon Corrosion Rate

<200 Å/month as defined by AHSRAE TC9.9.